

CERTIFIED ISO 9001

RF DUMMY LOADS, CALORIMETERS AND

COOLING EQUIPMENT FOR ELECTRONICS

MILITARY • MEDICAL • LASERS • RESEARCH
COMMUNICATIONS • SHIPBOARD • AVIATION • RADAR

Catalog 2000



ABOUT THE COMPANY

ELECTRO IMPULSE LABORATORY, INC. (also trading as Electro Impulse, Inc.) was originally founded in 1949 as a research and development enterprise. Since then our ideas have become so popular that we now have a broad product line and are recognized as a leading supplier of specialized cooling equipment to the electronic industry and the military. In addition, we have a line of RF products including dummy loads and calorimeters. **ELECTRO IMPULSE** cooling systems serve a wide variety of

applications from spacecraft support to cooling electronics in a pod under an aircraft, to cooling a laser used in a light show. Other units are used to cool medical and industrial imaging equipment in hospitals and mobile installations. **ELECTRO IMPULSE** products are in use worldwide.

ELECTRO IMPULSE equipment is in wide use by the military. An early example of one of our products is on display at the USS Intrepid Sea, Air and Space Museum in New York City. In the aerospace field, we have provided equipment for programs such as AATF, ASARS, ATHP, ATF, AWACS, AMRAAM, BEAR, PAVE SPIKE, Patriot, Tomahawk, F-14, F-15, F-16, F/A-18, F-22, EF-111, B-1B, Peacekeeper, HARM, SLCAIR, SLQ-32, ADR, EA-6B, ASPJ, AN/USC-38V, AN/SPS-40E, Rail Garrison, Starfire Optical Range, JSTARS, JSF, Minuteman Missile, SICBM, Trident and numerous others. We also manufacture an extensive line of electronic and mechanical support equipment including avionics air blower/cooler packages, hose/plumbing assemblies, coolant distribution panels, fluid purification units and deionization systems. **ELECTRO IMPULSE** has the experience, staff and capability to handle any application you may have, from standard units to your most complex applications.

TABLE OF CONTENTS

ABOUT THE COMPANY	1
FACILITIES	2
INTRODUCTION TO COOLING SYSTEMS	4
COOLANT SELECTION CHART	5
USEFUL FORMULAS	6
SELECTING THE COOLING METHOD	7
PUMPS AND RESERVOIRS	8
SPECIAL OPTIONS	9
TIPS	10
RU SERIES REFRIGERATED COOLING UNITS	11
CU SERIES LIQUID TO LIQUID HEAT EXCHANGERS	12
CUW SERIES LIQUID TO LIQUID HEAT EXCHANGERS ...	13
DUMMY LOADS	14
CALORIMETERS	18
COOLING SYSTEMS APPLICATIONS QUESTIONNAIRE ...	21



Company President
Mark Rubin receiving
1998 Region II
Small Business Subcontractor
of the Year Award.



ELECTRO IMPULSE LABORATORY, INC.
1805 Route 33, P.O. Box 278
Neptune, NJ 07754-0278
FAX: (732) 776-6793 PHONE: (732) 776-5800
Visit Our Web Site: www.electroimpulse.com

FACILITIES

ENGINEERING, QUALITY and DOCUMENTATION

“The Key Words at **ELECTRO IMPULSE**”

All of your products are engineered, designed and assembled by our staff in ELECTRO IMPULSE's 60,000 square foot modern manufacturing facility.

Our engineering department has overall involvement with every project, including design, manufacture and test. Our engineers and draftsmen use CAD programs and equipment to document all designs and changes.

IN-HOUSE METAL FABRICATION

- WELDING
- FRAME & PANEL FABRICATION
- PAINTING
- MACHINING OPERATIONS

This capability ensures quick, high quality fabrication of components to support our design operations. Skilled, certified craftsmen, with many years of experience and service, fabricate your stainless steel and aluminum components and assemblies.

ASSEMBLY/PRODUCTION

A well organized management/production team provides support from start to finish in making certain they have the proper parts, documentation and instructions for all work. Milestones are set up for every job and production and design reviews are held frequently.

FINAL TESTING

Every unit manufactured by **ELECTRO IMPULSE** is thoroughly tested, assuring that it will meet all customer required specifications. An acceptance test procedure helps guide each unit through this testing phase, and serialized test data is recorded for every unit.

Our Test Department is equipped with a wealth of state-of-the-art test and measuring equipment. This includes power sources to simulate worldwide voltages and frequencies (including DC, 50, 60 and 400 Hz), environmental test chambers and test loads to satisfy our customers requirements. Other special services (such as shock and vibration testing) are also available.



QUALITY ASSURANCE START TO FINISH



ELECTRO IMPULSE is certified to ISO 9001 through QMI and IQNet, ensuring a world class quality system. Our reputation of excellence is built on this quality system, which covers every phase of operation from engineering through production and final shipment. We offer agency listings such as UL1995 and CE. Other certifications are available. *Our goal is to provide our customers with excellent products, engineering and service support that meets their quality, technical and schedule requirements.*

NRTL LISTED



CERTIFIED
ISO 9001

† Listing # ELE31995



TECHNICAL ASSISTANCE

At ELECTRO IMPULSE we stand ready to provide you with accurate and precise technical assistance and troubleshooting techniques when required or needed. You are never more than a phone call away from our highly qualified and experienced Specialists and Engineering Department. Our professional staff is pleased to offer assistance and recommendations you can trust throughout all phases of any project, from your initial inquiry throughout the unit's service life.

INVENTORY

A large inventory of component parts and sub-assemblies is maintained for production and spare parts support of all ELECTRO IMPULSE units, regardless of age.

PRODUCT SUPPORT

Our products are designed for years of reliable operation. ELECTRO IMPULSE warrants all products to be free from defects in material and workmanship for a period of one year. We stand behind the quality of our products, regardless of age. Please call us if you require any support.



† Available on select units

INTRODUCTION TO COOLING SYSTEMS

Adequate heat dissipation in electronic and industrial equipment can often determine the overall design and performance of the system. Improper or inadequate cooling can severely shorten the life of many components and effect operating characteristics. Although simple convection or forced-air cooling techniques will satisfy many requirements, those in which power density is over ten watts per square inch are usually better met by liquid cooling.

The use of liquid cooling also eliminates the acoustic noise and vibration associated with forced air, since the cooling package can be remotely located.

Where large volumes of cooling liquid are required, a closed-loop system offers economy, control and dependability. Closed-loop cooling systems recirculate water, other liquids or air to the heat load and back, requiring no refilling of the system. Thus, they cut water consumption rates, eliminate sewer taxes and ease the load on plant cooling systems. Further, they offer the advantage of being able to filter, purify, deionize and control the coolant to any desired level of purity, temperature and flow.

Liquid cooling, using water or other fluids, is simply the removal of heat from the equipment being cooled to a heat sink or ultimate coolant, via a liquid or air medium. This catalog describes design considerations, applications and characteristics of cooling units of this type available to the industry.

ELECTRO IMPULSE offers both standard and special product lines of closed-loop coolers using both direct heat exchange and refrigeration. The information contained in this catalog is intended to furnish the reader with insight into the characteristics, applications and specification of such units.

ELECTRO IMPULSE cooling systems are world renowned for their reliability and high quality of construction. OEMs, laboratories, hospitals and the military choose **ELECTRO IMPULSE** as their chiller of choice.

Selecting the Coolant

Water is the most common and efficient coolant used in recirculating cooling. However, there are many applications where water is not suitable because of its corrosiveness, freezing/boiling points, conductivity etc. There is a wide variety of alternative coolants available. Some of the most popular coolants are shown on the Coolant Selection Chart. The characteristics of coolants differ so significantly that they can dictate the design of the cooling system, so it is important to select the proper coolant.

When deciding what type of coolant to use, some of the factors which should be considered are:

1. Operating and storage temperatures.
2. Operating and storage pressures.
3. Heat transfer capability.
4. Viscosity and specific gravity.
5. Flammability, toxicity, safety, ozone depleting characteristics and handling considerations.
6. Compatibility with system materials, including seals and pumps.
7. Dielectric strength, conductivity/resistivity, color and appearance.
8. Cost and availability.
9. Environmental factors.

Save Water and Money

Running tap water through your equipment is wasteful and costly. If your equipment requires five gallons of water per minute, 24 hours per day, 365 days per year, you can send 2.6 million gallons of water down the drain each year! Switching from tap water cooling to a recirculating cooler may offer you many advantages. Unlike tap water the coolant you choose to circulate through your delicate equipment is free from particles, scale and organic matter. Recirculating coolers offer control over flow, temperature and pressure of your coolant increasing the efficiency of your equipment.

If a liquid-to-liquid CUW series cooling unit is employed and tap water is used as the ultimate heat sink, the tap water would be drawn and modulated only as needed to control the primary coolant temperature. This system decreases overall tap water consumption. A refrigerated CU series unit will eliminate the need for tap water all together.

COOLANT SELECTION CHART

Coolant	Type	Appearance (Color)	Usable Temp Range (°F)	Specific Heat (Btu/lb/°F) @ 100°F	Specific Gravity @ 100°F	Viscosity CS/SSU @ 100°F	K for $P=F \cdot \Delta T \cdot K$ @ 100°F
Water	-	Clear	35 to 212	0.997	0.9931	.7/6	146
Air ¹	-	-	-	0.240	0.075 ²	-	0.316
Ethylene Glycol 40% Water 60%	4	Clear ⁵	0 to 220	0.855	1.042	1.8/32	131
Ethylene Glycol 50% Water 50%	4	Clear ⁵	-30 to 225	0.82	1.055	2.2/33.5	127
Ethylene Glycol 60% Water 40%	4	Clear ⁵	-66 to 235	0.76	1.066	3.0/36	119
Propylene Glycol 40% Water 60%	4	Clear ⁵	10 to 206	0.92	1.021	2.3/33.5	138
Propylene Glycol 50% Water 50%	4	Clear ⁵	-25 to 210	0.862	1.027	3.2/36.8	130
Propylene Glycol 60% Water 40%	4	Clear ⁵	-50 to 217	0.825	1.03	4.5/41	125
PAO	Poly-alphaolefin	Clear	-55 to 265	0.54	0.783	5.4/43	62
Coolanol 20	Silicate Ester	Clear	-100 to 300	0.465	0.88	2.1/33	60
Coolanol 25R	Silicate Ester	Clear	-60 to 300	0.45	0.882	4.8/41	58
Coolanol 35R	Silicate Ester	Clear	-30 to 400	0.465	0.875	7.5/51	60
DC-200 ³	Dimethyl Silicon Fluid	Clear	-90 to 390	0.41	0.872	2.0/32.6	53
Dowtherm J	Aromatic Oil	Clear	-70 to 358	0.45	0.85	.6/6	56
Dowtherm G	Aromatic Oil	Amber	40 to 575	0.387	1.09	8.19/53	62
Diala AX ⁷ Univolt 33	Mineral Oil (Transformer)	Amber	30 to 310	0.44	0.874	10.2/60	57
Marcol 87 (CS)	Mineral Oil (White Oil)	Clear	30 to 310	0.44	0.84	16.8/84	54
MIL-H-5606	Mineral Oil (Hydraulic)	Red	30 to 475	0.44	0.85	13.3/70	55
Fluorinert FC75/FC77/FC104	Fluoro-Carbon	Clear	-120 to 210	0.25	1.75	.63/6	64

ALL DATA IS APPROXIMATE - NOT RESPONSIBLE FOR ERRORS OR OMISSIONS.
All properties at 100°F unless otherwise noted.

¹ Values given at sea level, 70°F.

² Density in lb/ft³.

³ DC-200 is a brand name covering a family of coolants of various viscosities. Properties are those of a light grade: 2 centistokes at 25°C (77°F).

⁴ Special inhibitors may be required. Consult factory.

⁵ Commercial anti-freeze may be colored.

⁶ Below range of scale.

⁷ Values given at 60° F.



USEFUL FORMULAS AND CONVERSIONS

DETERMINATION OF TEMPERATURE RISE ACROSS A HEAT LOAD

LIQUID COOLING SYSTEMS

In a liquid cooled system the heat rise of the coolant across a load can be related to its flow rate and the heat load by the general formula:

$$P = F \cdot \Delta T \cdot SG \cdot SH \cdot 145.7$$

or

$$\Delta T = P / (F \cdot SG \cdot SH \cdot 145.7)$$

Where:

P = Power or heat load, in Watts

F = Flow Rate, GPM

ΔT = Temperature rise of the coolant, °F

SG = Specific gravity of the coolant at average coolant temp.

SH = Specific heat of the coolant at average coolant temp., Btu/(lb_m·°F)

If the specific gravity and specific heat of the coolant are not known use "K" from the coolant selection chart, assuming 100°F average coolant temperature, in the following formula:

$$P = F \cdot \Delta T \cdot K$$

or

$$\Delta T = P / (F \cdot K)$$

AIR COOLING SYSTEMS

Air temperature rise across a heat load can be related to the air flow rate and the heat load by a similar formula:

$$P = C \cdot \Delta T \cdot D \cdot SH \cdot 17.58$$

or

$$\Delta T = P / (C \cdot D \cdot SH \cdot 17.58)$$

Where:

P = Power or heat load, in Watts

C = Air Flow Rate, CFM

ΔT = Temperature rise of the air, °F

D = Density of the air at average temp., lb_m/ft³

SH = Specific heat of the air at average temp., Btu/(lb_m·°F)

If the density and specific heat of the air are not known use "K" from the coolant selection chart, assuming 70°F average air temperature at sea level, in the following formula:

$$P = C \cdot \Delta T \cdot K$$

or

$$\Delta T = P / (C \cdot K)$$

CONVERSION FACTORS

Power

$$1W = 3.413 \text{ Btu/hr}$$

$$1HP = 745.7 \text{ W}$$

Temperature

$$^{\circ}\text{C} = (^{\circ}\text{F} - 32) \cdot (5/9)$$

$$^{\circ}\text{F} = ^{\circ}\text{C} \cdot (9/5) + 32$$

Flow

$$1 \text{ LPM} = .264 \text{ GPM}$$

Specific Heat

$$1\text{kJ}/(\text{kg}\cdot^{\circ}\text{C}) = .23885 \text{ Btu}/(\text{lb}_m\cdot^{\circ}\text{F})$$

Density

$$1\text{kg}/\text{m}^3 = .062428 \text{ lb}_m/\text{ft}^3$$

Pressure

$$1\text{kPa} = .145 \text{ psi}$$

$$1 \text{ psi} = 2.307 \text{ ft head}$$

SELECTING THE COOLING METHOD

Once the coolant is selected, the next step is to select the cooling method. This refers to whether refrigeration is employed or not, and how the heat (which the primary recirculating coolant removed from the heat load) is finally dissipated. Our most popular RU-300, with water as the primary coolant, utilizes refrigeration to remove heat from the water and reduce its temperature below ambient. This heat is then exhausted via the refrigeration condenser to ambient air. This is a refrigerated, air cooled unit. But this heat (a combination of the heat removed from the heat load and motor inefficiencies in the cooling unit) could raise the ambient room temperature beyond acceptable limits, causing the cooling unit to lose efficiency and possibly overload the room's air conditioning system. In such a case alternative types of cooling are available; for example, the cooling unit could be relocated outdoors (be sure to specify an outdoor unit), or the unit could be fitted with a water cooled condenser (if tap or facility water is available) to remove the heat. Another method is to employ a split refrigeration system. This allows the pumping unit to be located indoors and the condensing unit outdoors. Therefore the heat is rejected to the outdoor ambient. *It should be noted that all cooling units should be located away from walls and other obstacles to provide for proper air flow.*

Remember: The recirculated closed loop coolant is referred to as the primary coolant. The ultimate coolant to which the heat is finally exhausted is referred to as the secondary coolant. All performance measurements of cooling units are measured at the discharge port.

The general types of cooling methods are shown in the chart below. Other cooling methods such as ram air, liquid nitrogen cooling or other special cooling methods are also available.

Type	Model Series	Advantages	Disadvantages
Liquid-to-Air, Non-refrigerated	CU	<ul style="list-style-type: none"> Highly efficient Economical Simplest design 	<ul style="list-style-type: none"> Dissipates heat into room Primary recirculated coolant is always above ambient air temp
Liquid-to-Liquid* Non-refrigerated	CUW	<ul style="list-style-type: none"> Quiet operation Simplest design Most Efficient Cooling tap water is drawn only as needed 	<ul style="list-style-type: none"> Primary recirculated coolant is always above secondary water temp Availability of tap/facility water Cost of tap/facility water
Liquid-to-Air, Refrigerated	RU	<ul style="list-style-type: none"> Best temp. control Primary liquid is brought below ambient air temp. 	<ul style="list-style-type: none"> Dissipates heat into room More expensive than CU/CUW type
Liquid-to-Air, Refrigerated Split System	RU	<ul style="list-style-type: none"> All advantages of one piece RU series Heat is expelled outdoors Quiet operation 	<ul style="list-style-type: none"> Set-up cost Typically more expensive than one piece RU series
Liquid-to-Liquid*, Refrigerated	RUW	<ul style="list-style-type: none"> Best temp. control Quiet operation Primary liquid is brought below secondary (tap) water temp Cooling tap water is drawn only as needed 	<ul style="list-style-type: none"> Availability of tap/facility water Cost of tap/facility water More expensive than CU/CUW series
Air Circulating/ Cooling Unit	RC	<ul style="list-style-type: none"> Circulates /cools air as primary medium Can be refrigerated or direct heat exchange Suitable for rack or cabinet cooling 	<ul style="list-style-type: none"> Custom built series only-consult factory for details

*Tap, facility water, or other liquid, provided by customer

PUMPS AND RESERVOIRS

A closed loop liquid cooling system utilizes a pump to circulate the coolant to the heat load and back to the cooling unit.

Various types of pumps are used in ELECTRO IMPULSE cooling units, depending on the coolant and the flow, pressure and temperature requirements of the application. Our cooling units generally use vane, gear, turbine or centrifugal pumps, whichever is best suited for the application. These pumps are designed for continuous duty at maximum rated pressure and, where necessary, are fitted with a bypass pressure relief valve to protect the pump and system from excessive pressures. Some coolants and applications require the use of special pumps such as wet motor designs, sealless magnetic drive pumps and pumps designed for extreme temperature ranges. Many types of pumps are available, including those designed for 50Hz, 400Hz, or for DC line voltages.

Higher pressure pumps may be required in some cases. This often depends on the characteristics of the piping between the recirculating cooler as well as the customer's equipment to be cooled. There are several factors which can lead to a large pressure drop (and hence the need for a higher pressure pump). Some of these factors include:

- The recirculating fluid viscosity is greater than 20 centistokes.
- The external interconnecting piping is improperly sized for the required flow rate.
- There is a long length of interconnecting piping (i.e. a long distance between the cooling unit and the equipment to be cooled).
- Other restrictions to fluid flow within the equipment to be cooled.
- The equipment to be cooled is on a higher elevation than the cooler.

The inlet (or suction) of the pump is typically connected directly to a stainless steel reservoir with the following characteristics:

- Full flow-through design.
- Sealed from ambient air and protected from over pressure.

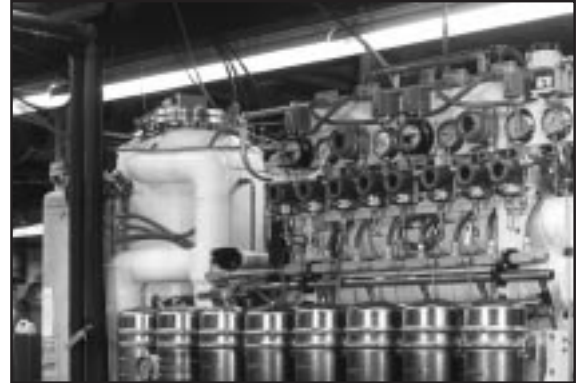

- Allows for filling of the coolant.
- Allows for purging of entrained air/gasses from the coolant.
- Provides for a positive suction head to the pump inlet.
- Allows for expansion of the coolant. Some of our special units may employ accumulators or other equipment, in addition to, or in place of the reservoir.
- Has pressurizeable nitrogen blanket options.

SPECIAL OPTIONS

Instrumentation and Interlocks

Most ELECTRO IMPULSE cooling systems are supplied standard with a coolant supply pressure gauge, coolant supply temperature gauge, reservoir level gauge, over-temperature and low flow switches and front panel fault indication. There are many other optional choices available depending on customer requirements, such as:

- Flow Meters
- Resistivity/Conductivity Instruments
- Computer Interfaces
- Digital Displays
- Reservoir Level Switches

Environmental Concerns

ELECTRO IMPULSE is concerned about using only environmentally friendly refrigerants in all new designs. We can also support older equipment. We employ licensed refrigeration technicians and refrigerant recovery equipment. We are pioneers in the use of environmentally friendly refrigerants and coolants.

Temperature Controls

Our refrigerated units feature a high accuracy solid state temperature control system. The refrigeration system uses hot gas bypass circuitry for excellent temperature control over varying heat loads.

Deionizers

We can provide active deionization equipment that will condition and maintain water solutions for high resistivity applications.

Filters and Strainers

We are specialists in filtration of flowing liquids. Coolants can pick up and carry particles of dirt, corrosion and other system impurities, which can not only damage the cooling system, but can also foul the user's equipment. Depending on requirements, filters and strainers can be provided. They can be fitted with filter differential gauges, switches, indicators and bypass loops, enabling the filter to be changed while the cooling unit continues to operate.

Outdoor/Weatherproof Units

Our optional outdoor and special application units are designed with all the necessary components, hardware and cabinetry to supply highly reliable systems capable of withstanding years of use in the extreme/special environments for which they are designed. We can provide systems for any application, including outdoor installations, harsh environments, or shipboard and airborne applications. Please contact us with your requirements, as we will be pleased to quote on special or unique requirements.

Multi-Path Outlet

We can provide units with multiple path outlets so that one cooling unit can cool multiple heat loads. The cooling system may be fitted with distribution manifolds, additional pumps and instrumentation and interlocks for each path as required by the customer.

Microprocessor Compatibility

The cooling unit operation is directed by a proven control system that can be integrated with microprocessor monitoring and control systems. Flow rate, refrigeration system operation and coolant temperature are precisely controlled to maintain cooling to specified limits.

Miscellaneous Options

- Heater Packages
- Auto Reservoir Fill
- Extended Temp Range
- Discrete Interlocks
- Remote Controls
- Seawater Compatible
- High Ambient Temp Pkg.

TIPS FOR SELECTING AND INSTALLING CLOSED LOOP COOLING SYSTEMS

1. ELECTRO IMPULSE cooling units are rated for performance at the supply connection of the cooling unit. Thus, any external heat load or pressure drop must be considered part of the total load when sizing a cooling unit. Therefore, the pressure drop and heat losses of hoses, inter-connecting fittings, etc. must be taken into account by the user. The following minimum line sizes are recommended when connecting the cooling unit to the heat load. If in doubt, always use the next larger size hose or pipe.

Minimum Line Sizes for less than 5 PSI Drop

Flow GPM	Hose Size, Inside Diameter (Inches)	Equivalent Pipe Size (Inches)
1	3/8	1/4
2	1/2	3/8
4	5/8	1/2
10	3/4	3/4
20	1	1

Coolant: Water

Total Line Length: 50ft. (25ft. each direction)

Also consider the thermal load imposed by room ambient, solar heating, etc. on the system, including hoses. This must be considered as part of the heat load. For refrigerated units, it is recommended that all hose runs be insulated to prevent condensation and loss of capacity.

2. Line Voltage: Because closed loop cooling systems employ motors and compressors, correct line voltage, phasing and frequency is very important.

3. Consider the amount of heat added by the cooling unit to the room. Normally, the amount of heat added to the room by an air cooled unit is the amount of power removed from the heat load, plus an additional 30% (approximate) for the motor heat. If an air cooled unit is to be operated in an air conditioned room, consider the added heat load imposed on the air conditioning system. In any case, make certain that proper ventilation of the room is provided such that the ambient temperature does not rise above the maximum limits.

If heat rejection into the room is unacceptable you may relocate the unit or select an alternate cooling method, i.e. liquid-to-liquid (CUW Series), water cooled condenser (RUW Series), split system or an outdoor unit.

4. Change coolant, filters and deionizer elements regularly to maintain performance. The frequency of replacement of these elements depends largely on the amount of impurities in the system and the quality of the coolant used in the initial filling. Normally, filter elements

should be changed within 1-2 weeks after unit startup, and then a minimum of every 6 months thereafter. Increased frequency of replacement may be needed depending on system conditions. Circulating coolants should be changed or reconditioned every 6-12 months depending on use.

5. Use of deionized water in standard units: The wetted path in our standard units designed for use with water typically include stainless steel, copper, synthetic rubbers, plastic and limited amounts of nickel plated non-ferrous alloys, all of which are compatible with deionized water and/or water/glycol solutions. If deionized water solutions are to be used in our cooling units, ELECTRO IMPULSE highly recommends the use of a deionizing filter system to maintain coolant purity and cleanliness. Optional deionizing filter systems are available for all our standard units. Please consult with the factory for further details.

6. If you have any problems our engineering staff is always available to help you. Please feel free to call us. We stand behind our products and we will assist you in any way we can.



RU SERIES REFRIGERATED LIQUID COOLING SYSTEMS

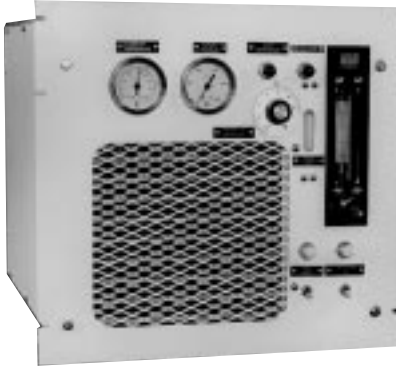

**CFC Free
OZONE
FRIENDLY**

NRTL LISTED
MET.
CERTIFIED
ISO 9001

† Listing # ELE31995

with Built-In- Circulating System Air (RU) or Water (RUW) Cooled Condenser

Coolant may be water, glycol/water solutions, PAO, Coolanol, Fluorocarbons or other liquids. CFC free, sealed refrigeration system features high efficiency liquid-to-refrigerant heat exchanger incorporating a hot gas bypass system for close temperature control and freeze protection. A wide variety of options is available including deionizers, flow meters, flow control valves, computer interfacing and outdoor/weatherproof units.

Easy installation. Connect supply and return lines to heat load, connect line power, ground and safety interlock and fill system with coolant.

Water cooled condensing units (RUW Series) are available. They require customer supplied tap or facility water as the secondary coolant.

APPLICATIONS

CAT Scan, X-ray machines, MRI, Lasers; Pharmaceutical, Medical, Industrial processes; Holography.



Model	Amb. 70° F Capacity Watts Water @ 65° F	GPM Flow @ 50 PSID
RU-50	1,600	1.5
RU-75	2,400	1.5
RU-100	3,200	1.5
RU-200	8,000	4.0
RU-300	13,500	4.0
RU-400	17,500	4.0
RU-500	21,500	8.0
RU-750	30,000	8.0
RU-1000	40,000	10.0
RU-1500	60,000	15.0
RU-2000	80,000	20.0

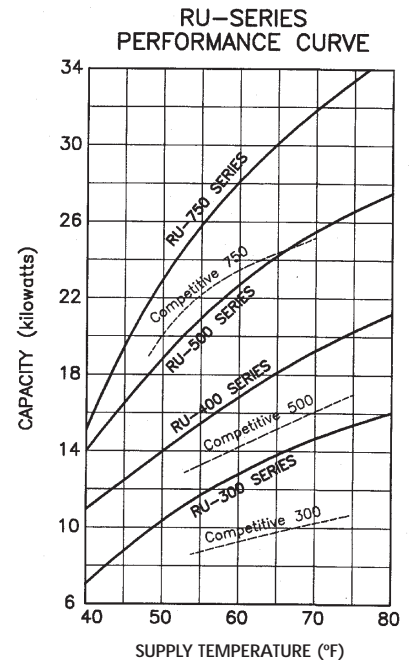

Performance data representative of standard units using water. Consult the factory for other flow rates, coolants (glycol, coolanol, PAO, Fluorocarbons, etc.), voltages and frequencies (50Hz, 400Hz) and larger refrigerated units. Specifications subject to change without notice.

† Available on select units

CU SERIES LIQUID TO AIR HEAT EXCHANGERS



*Uses Ambient Air as Ultimate Heat Sink.
Non-Refrigerated Heat Exchangers.*

- Highly efficient and economical.
- Use where coolant temperatures are less critical and may be above ambient.
- Coolants may be water, glycol/water solutions, PAO Coolanol, Fluorocarbons, etc.
- Outdoor and custom units available.

NRTL LISTED



† Listing # ELE31995

CERTIFIED
ISO 9001

APPLICATIONS

Radar Systems, Aircraft Ground Support, High Power Amplifiers, RF Dummy Loads, Lasers

CU SERIES STANDARD HEAT EXCHANGE UNITS



Model	Water Temp. Rise °F/Kw Over Ambient	GPM Primary Flow @ 50 PSID
CU-500*	20.0	0.5
CU-5,000*	4.5	1.5
CU-10,000	3.0	4.0
CU-20,000	1.8	4.0
CU-30,000	1.0	4.0
CU-50,000	0.5	12.0
CU-80,000	0.4	15.0
CU-100,000	0.3	20.0

*19" Rack Mount

Capacities/Range are for water; consult factory for other coolants. Table above represents typical values only; consult factory for different flow rates, voltages, capabilities, etc. Specifications subject to change without notice.

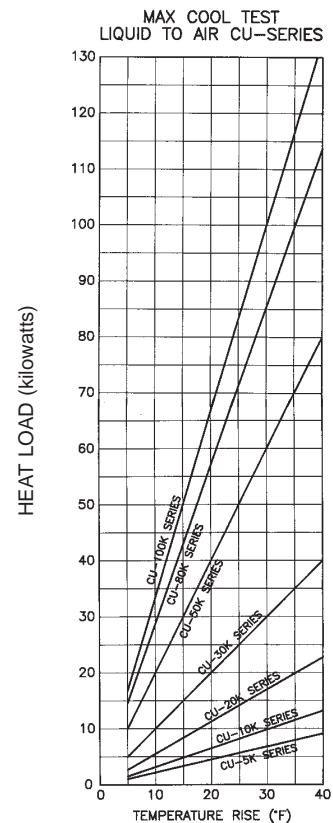

CUW SERIES LIQUID TO LIQUID HEAT EXCHANGERS



Non-Refrigerated Heat Exchangers

Electro Impulse CUW series water-cooled, non-refrigerated units provide one of the most efficient and convenient types of cooling. Heat is dissipated from customer's liquid coolant to tap or facility water. Wide selection of coolant types in both primary (recirculating) and secondary (customer supplied, ultimate heat sink) coolant, including water, glycol/water solutions, PAO, fluorocarbons or other liquids. Use where coolant temperature control is less critical. Recirculating coolant temperature will be slightly above incoming tap or facility coolant temperature.

Liquid cooled units allow circulation of controlled, high purity water (or other coolants) in a closed loop, with high efficiency and low noise. Secondary coolant is automatically modulated by cooling system to conserve water and provide primary loop temperature control. Minimal heat is added to room ambient.

ELECTRO IMPULSE CUW series cooling units have extremely high heat transfer efficiency. As the graph below shows, our units provide lower coolant temperatures while using far less water than those of any known competitor. This is made possible by use of proprietary heat transfer arrangements which utilize compound flows, enhanced surface area and approach temperatures which are optimized by true counterflow arrangements.

NRTL LISTED



CERTIFIED
ISO 9001

† Listing # ELE31995

APPLICATIONS

Lasers, X-ray machines, RF dummy loads, MRI, Radar, Communications



CUW Series Standard Heat Exchange Units

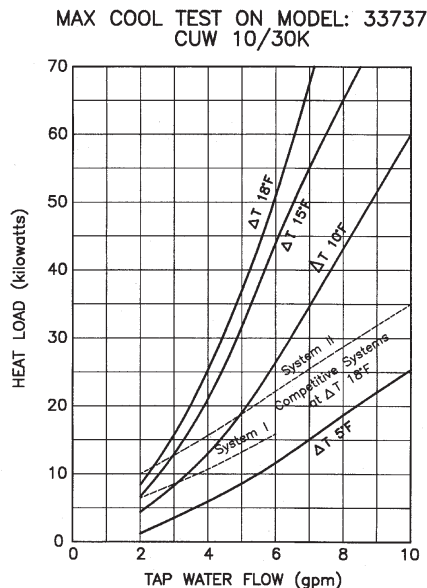

Model	*Watts Removed	GPM Primary Flow@ 50 PSID
CUW-5000	5,000	1.5
CUW-10,000	10,000	4.0
CUW-10/30K	30,000	4.0
CUW-50,000	50,000	8.0
CUW-80,000	80,000	12.0
CUW-100,000	100,000	15.0

* All performance ratings are based on primary coolant being delivered at 20°F, or less, above temperature of secondary tap water. Capabilities/ratings are for water. Consult factory regarding other coolants. Table above represents typical values only. Consult factory for other flow rates, voltages, capacities, etc. Specifications subject to change without notice.

DUMMY LOAD INTRO/TIPS

ELECTRO IMPULSE, Inc. manufactures standard and custom loads for the broadcast and communications industry. These loads have power ratings from 1500 Watts average to 10 Megawatts peak power.

We can meet any special load requirement you may have. As an example, here are some special loads which we have produced for both the military and industry:



- 600,000 Watt air-cooled test load for a Very Low Frequency (VLF) shore station radio transmitter.
- 10 megawatt pulse liquid cooled RF load qualified for military airborne applications.
- Dry, forced-air cooled load for 400 KW continuous average power, up to 110 MHz.
- Twin line (balanced input) loads for rhombic antenna outdoor use.
- Low IM distortion loads allowing IM distortion measurements to -85DB.

These special requirements are typical of our ability to produce small or high volume loads on a special or standard basis with quick turnaround capability.

Our standard product line of loads includes many state of the art designs. We pioneered the development of dry, forced-air cooled loads, for use up through FM broadcast frequencies, which are now extremely popular in the broadcast industry. Our DACT Series of loads was the first dry, convection cooled series. These types of loads have become extremely popular, both domestically and internationally, as the availability of tap water for cooling decreases, and the importance of reliability of a dry load is recognized.

TIPS ON LOAD SELECTION

1. Notice to Broadcasters:

AM transmitters must be matched with a load that can handle the full carrier output, PLUS modulation. Therefore, a 10,000 watt AM transmitter requires a 15,000 watt load. For FM use, only the carrier output power needs be considered.

2. Peak Power Ratings:

All loads listed herein handle Peak Envelope Power (PEP) of up to twice the average power rating. However, higher peak powers, including pulse applications, require special consideration involving peak voltage and current, and peak energy levels (expressed in joules). Some of our loads can handle exceptionally high peak powers (such as most of our dry convection and forced air cooled loads). Please check with the factory whenever you have a pulse application.

3. Average Power Ratings:

All average power ratings listed herein are continuous except as otherwise noted. We guarantee the average power ratings of all loads as advertised.

4. Dissipated Heat:

The amount of RF power terminated by an air cooled load will be dissipated as heat into the space where the load is operating. Be certain to consider this additional heat load on air conditioning and cooling systems. Normally, when large loads are installed in transmitter rooms, a ventilation system is installed which matches the air flow of the load. This will effectively pull all of the heated air out of the room and is an acceptable method to maintain room temperature. During the winter this ventilation system may be shut off to provide an economical means of heating the room. Please consult with the factory for details on air flow and ventilation requirements. Do not connect an air duct to any load unless it is specifically designed for this application. Air exhaust ducts present an air flow back pressure to the load and reduce air flow. This can cause load overheating and failure. We can provide loads with ducted outputs for special installations upon request. Many loads, especially those which are dry, convection cooled, run hot under full power. Provide adequate clearance and ventilation when considering the installation location of a load. Also consider that any dry load will run cooler if forced air flow is provided for it.

DACT-5KFM DACT-7.5KFM

DPTC-10KFM

DPTU-153^(AM BAND) DACT-153^(TO 30 MHz)

50 OHMS NOMINAL

50 OHMS NOMINAL

50 OHMS NOMINAL



**5000-7500
Watts**

10,000 Watts

15 KW

DRY, CONVECTION COOLED

Frequency: DC - 110 MHz

VSWR: 1.1:1 Max.

Power: 5000 Watts Continuous

**7500 watts Intermittent

Ambient: -40 to +52°C

Input: 1-5/8, 3-1/8

Weight: 65 pounds

Op. Position: Upright only

Overtemp Interlock Available

** 7500 watts continuous average power limited to 30 minutes on/30 minutes off.

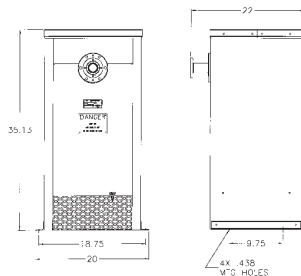

DRY, FORCED AIR COOLED

Frequency: DC - 110 MHz

VSWR: 1.1:1 Max.

Power: 10,000 Watts Continuous

Ambient: -40 to +40°C

Input: 3-1/8, 1-5/8

Weight: 75 pounds

Op. Position: Upright only

Air Flow: 580 CFM

AC Power: 115 VAC 5A 60Hz

(50 Hz Optional extra)

Temperature Interlocked

Reject Load Option Available

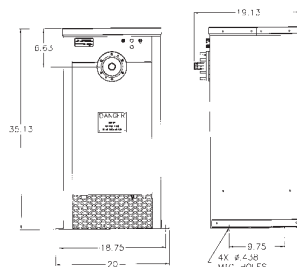

**DRY, CONVECTION COOLED
NO LINE POWER NEEDED**

Frequency:

(AM)DC-1750 KHz (DPTU-153)

DC-30 MHz (DACT-153)

VSWR: 1.1:1 Max.

Power: 15 KW Continuous

Ambient: -40 to +52°C

Input: 1-5/8, 3-1/8

Weight: 90 pounds

Op. Position: Upright

Interlock: Thermostat included

IDEAL FOR 10KW

AM TRANSMITTER

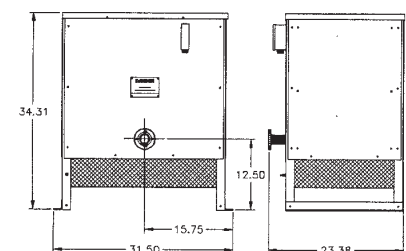

DPTC-25KFM

50 OHMS NOMINAL

DPTC-50KFM

50 OHMS NOMINAL

DPTC-75KFM

50 OHMS NOMINAL

DPTU-75K

50 OHMS NOMINAL



25 KW

50 KW

75 KW

80 KW

DRY, FORCED AIR COOLED

Frequency: DC - 110 MHz
 VSWR: 1.15:1
 Power: 25 KW Continuous
 Ambient: -40 to +45° C
 Input: Std. 3-1/8
 Avail.: 1-5/8
 Weight: 92 pounds
 Op. Position: Upright
 Air Flow: 850 CFM

- Interlocked for line power, and overtemperature
- AC Required: 115VAC 8A 60Hz (50 Hz available optional)
- Reject load option available

DRY, FORCED AIR COOLED

Frequency: DC - 110 MHz
 VSWR: 1.15:1
 Power: 55 KW cont
 Ambient: -40 to +45° C
 Input: Std. 3-1/8
 Weight: 115 pounds
 Op. Position: Upright
 Air Flow: 1900 CFM

- Interlocked for line power, and overtemperature
- AC Req'd: 220VAC 7A 60Hz (50Hz available optional)
- Reject load option available.

DRY, FORCED AIR COOLED

Frequency: DC - 110 MHz
 VSWR: 1.15:1
 Power: 75 KW continuous
 Ambient: -20 to +40° C
 Input: Std. 3-1/8
 Avail: 4-1/16
 Weight: 425 pounds
 Op. Position: Upright
 Air Flow: 2100 CFM

- Interlocked for line power and overtemperature
- AC Req'd: 208/230 VAC 12.5A 60Hz (50Hz available optional)

NOT AVAILABLE
 USE DPTC - 75 KFM

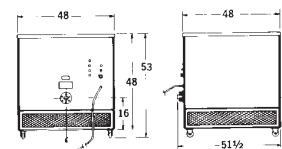
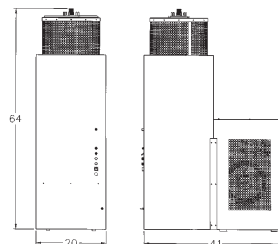
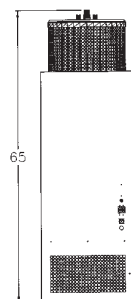
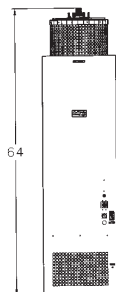
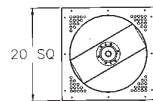
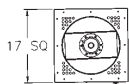

CALORIMETERS

Introduction to Calorimeters

The calorimetric principle is considered the most accurate method for the measurement of RF power. The measurement of electrical power using this principle depends upon the conversion of the electrical energy, as delivered by an RF source, into thermal energy in a resistive load. This temperature rise can be measured (with a thermopile located between the load coolant inlet and outlet, for example), and when applied properly, can provide the means for accurate RF measurement.

A calorimeter is a device which uses the calorimetric principle to accurately measure RF power over a wide range of frequency and power levels and has the ability to measure true average power, even with complex waveforms.

A calorimeter is comprised of:

- A liquid cooled RF load with closely coupled thermopile and calibration resistor.
- Circulating pump/heat exchanger.
- Signal conditioning board with display.

A calorimeter can provide highly accurate RF power measurements traceable to NIST. Calibration procedures are based on AC substitution calorimetry. A source of AC power is applied to the load to simulate the heating effect of the unknown RF power, and is measured using readily available AC power sources and measuring equipment.

Calorimeter accuracy is expressed as a percentage of full scale, less load error. Only the power that is actually absorbed by the load is measured. All other power (reflected, etc.) is considered part of load error and is not measured. Load error can be predicted by calculation.

Figure 1 shows a typical calorimeter design. Circulating coolant flows through the RF load. A closely coupled thermopile senses the temperature rise across the coolant and produces a DC voltage directly proportional to the RF (or calibration) power applied, assuming flow remains constant. A heat exchanger removes the heat picked up by the fluid and exhausts it to ambient air or another liquid. The cooled fluid is then recirculated to the load in a closed loop. The DC voltage from the thermopile is fed into a signal conditioning board and then to a display, calibrated in RF watts (or a computer interface).

Figure 1

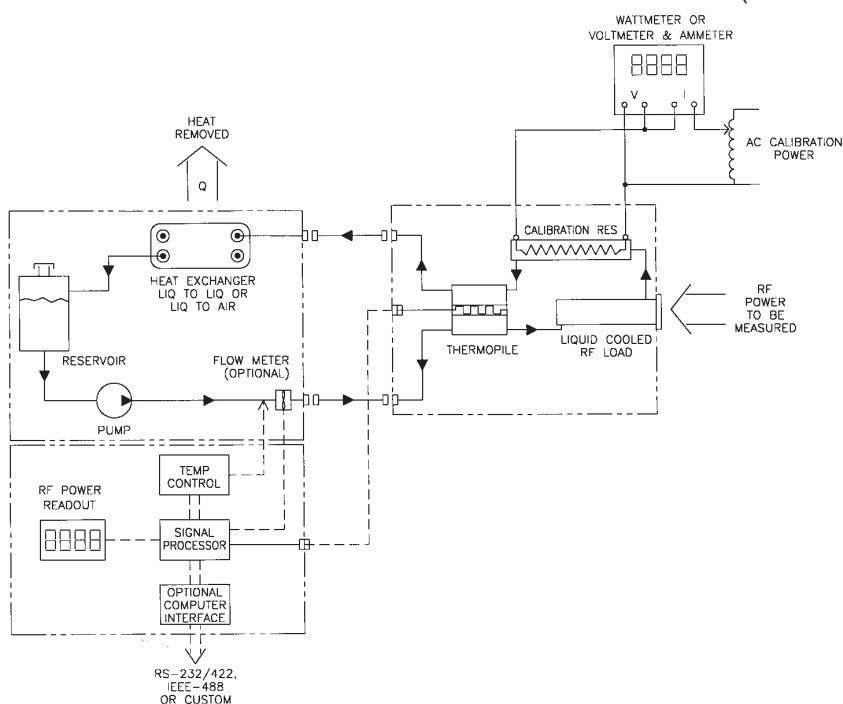

CALORIMETER LOAD ACCURACY

Figure 2 shows a typical calorimeter load design. The incident power, is shown as P_I (the power that is to be measured). P_A represents the power which is actually absorbed by the termination for conversion to heat. Power reflected by the termination and connector is shown as P_R . This portion of the load error can be predicted by calculation from VSWR data. P_M represents power absorbed by the load, but not transferred to the coolant stream. This factor is minimized by the design of the calorimeter.

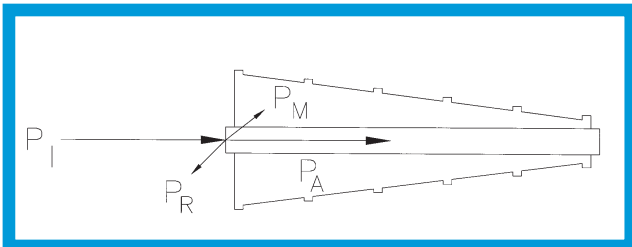

Figure 2

P_I = Incident Power

P_A = Power absorbed by load resistor

P_R = Power reflected at input connector

P_M = Power absorbed by load parts other than resistor



CALIBRATION

Calibration is an essential element in maintaining the accuracy of a calorimeter. The specific procedure is referred to as AC substitution calorimetry. A precisely measured amount of AC power is applied to the RF load input (or calibration resistor) which simulates the heating effect of the RF power. The known power is then used to adjust the calorimeter thermopile readout device to match the AC standard. The AC standard is measured with voltmeters and ammeters that have calibration traceable to NIST. This allows the calorimeter to act as a transfer standard to provide the rated accuracy, less load error, offered by the calorimeter.

Calibration equipment usually consists of:

- An adjustable, regulated source of low distortion AC power.
- High accuracy, true RMS reading, voltmeter and ammeter (or wattmeter).

Calibration power is applied directly to the RF load 50 ohm coaxial connector, if the load is of the internal resistor type. Many loads, such as waveguide, do not use a resistor; water is both the coolant and dielectric material. In this case a calibration resistor is supplied to simulate the heating effect of the RF load. Refer to Figure 1 for a typical calibration set up.

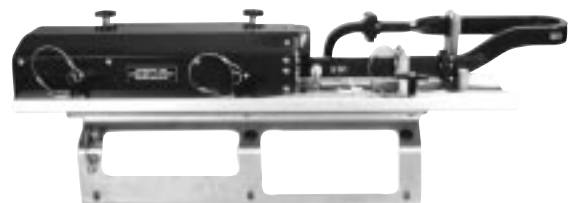
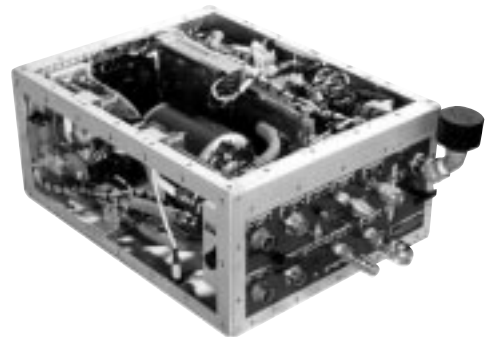

CALORIMETER-LOAD SELECTION CHART

These charts allow you to quickly select the proper calorimeter to meet your requirements and match it to a load. Special calorimeters and loads also available.

All calorimeters are offered as systems consisting of the calorimeter and one or more loads.

CALORIMETER SELECTION CHART

Model	Accuracy (F.S.)	Type Readout	Power Range (Watts)	Approx. Weight (lbs. Calorimeter Only)
HA-100	½%	Digital	15-100	70
HA-1000	½%	Digital	15-1000	70
HA-5000	½%	Digital	50-5000	100
HA-10,000	½%	Digital	300-10,000	280
ADR-100	1%	Digital	15-100	70
ADR-1000	1%	Digital	15-1000	70
ADR-5000	1%	Digital	50-5000	100
ADR-10,000	1%	Digital	300-10,000	280
CPM-15,000	2%	Digital	150-15,000	175
CPM-25,000	2%	Digital	300-25,000	215
CPM-30,000	2%	Digital	500-30,000+	250
CPM-50,000	2%	Digital	500-50,000	500
CPM-80,000	2%	Digital	500-80,000	600

LOAD SELECTION CHART

Load Model	Frequency Range (GHz)	VSWR	Connector	Power (Watts)
CLWT-13	DC-1	1.1:1	N, 7/8 EIA.	1000
	1-3	1.3:1		
	3-3.5	1.35:1		
CLWT-53	DC-500	1.15:1	1-5/8 EIA, 7/8 EIA	5000
	500-900	1.1:1		
	900-2000	1.25:1		
CLWT-153	1kHz-1	1.1:1	3-1/8 EIA	15,000
CLWT-253	1kHz-900	1.1:1	3-1/8EIA	25,000
CLWT-54	1kHz-900	1.1:1	3-1/8EIA	50,000
CLWT-84	1kHz-800	1.15:1	6-1/8EIA	80,000
19118	1-2.5	1.15:1	1- 5/8EIA	3000
WLT-650	1.12-1.70	1.2:1	UG-417/U	50,000
WLT-430	1.70-2.60	1.2:1	UG-435/U	30,000
WLT-340	2.20-3.30	1.2:1	UG-553/U	30,000
WLT-284	2.60-3.95	1.15:1	UG-53/U	25,000
WLT-187	3.95-5.85	1.15:1	UG149/U	10,000
WLT-159	4.90-7.05	1.15:1	CMR-159	10,000
WLT-137	5.85-8.20	1.15:1	UG-344/U	5000
WLT-112	7.05-10.00	1.15:1	UG-51/U	5000
WLT-90	8.20-12.40	1.15:1	UG-39/U	3000
WLT-62	12.40-18.0	1.15:1	UG-419/U	3000
WLT-42	18.0-26.5	1.15:1	UG-596/U	500
WLT-28	26.5-40.0	1.15:1	UG-600/U	300
WLDT-24	2.0-4.0	1.25:1	UG-1572/U	2000
WLDT-29	4.0-8.0	1.2:1	UG-1575/U	3000
WLDT-19	5.0-11.0	1.2:1	Specify	3000

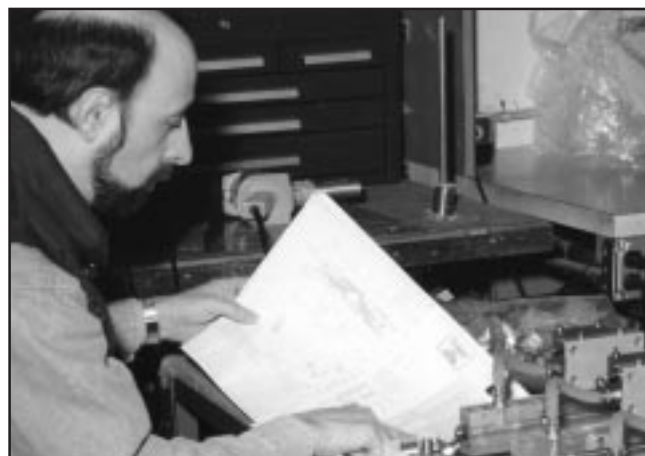

COOLING SYSTEMS APPLICATIONS QUESTIONNAIRE



Name: _____		
Company: _____		
Street: _____		
City: _____	State: _____	Zip: _____
Phone: _____	Fax: _____	

Equipment To Be Cooled: _____

Quantity Required: _____

Date Required: _____

Active Heat Load (Btu/hr or Watts): _____

Coolant Type (Water, Glycol, PAO, etc. See pg.5): _____

Coolant Flow Rate: _____

Coolant Supply Pressure at Rated Flow: _____

Maximum Coolant Pressure to Equipment (Blocked Discharge/No Flow): _____

Coolant Connections: _____

Coolant Supply Temperature: _____

Maximum Coolant Return Temperature: _____

Coolant Purity Specifications (If Applicable): _____

Filtration (Particulate, Deionizer, Oxygen Removal, If Required): _____

Cooling Method (RU, RUW, CU, CUW, see pg. 7): _____

Prime Input Power (Voltage, 1 or 3 Phase, Frequency): _____

Environment: Indoor/Outdoor (Sheltered/Non-Sheltered): _____

Ambient Operating Temperature: Min: _____ Max: _____

Ambient Storage Temperature: Min: _____ Max: _____

Special Environmental Conditions: _____

(Airborne, Shipboard, Coastal Proximity, Altitude, etc.)

Mounting (Casters, Mounting Channels/Skids, Rack Mount, etc.): _____

Noise Limits (If Applicable): _____

Instrumentation (Gauges, Indicators, Flow Meter, etc.): _____

Interlocks (Flow, Temperature, Level, etc.): _____

Additional Specifications (If Applicable): _____

Photocopy and fill in the above questionnaire as completely as possible. Mail or fax to Electro Impulse, Att: Applications Engineer

ELECTRO IMPULSE LABORATORY, INC.

1805 Route 33, P.O. Box 278

Neptune, NJ 07754-0278

FAX: (732) 776-6793 Phone: (732) 776-5800

VSWR NOMOGRAPH

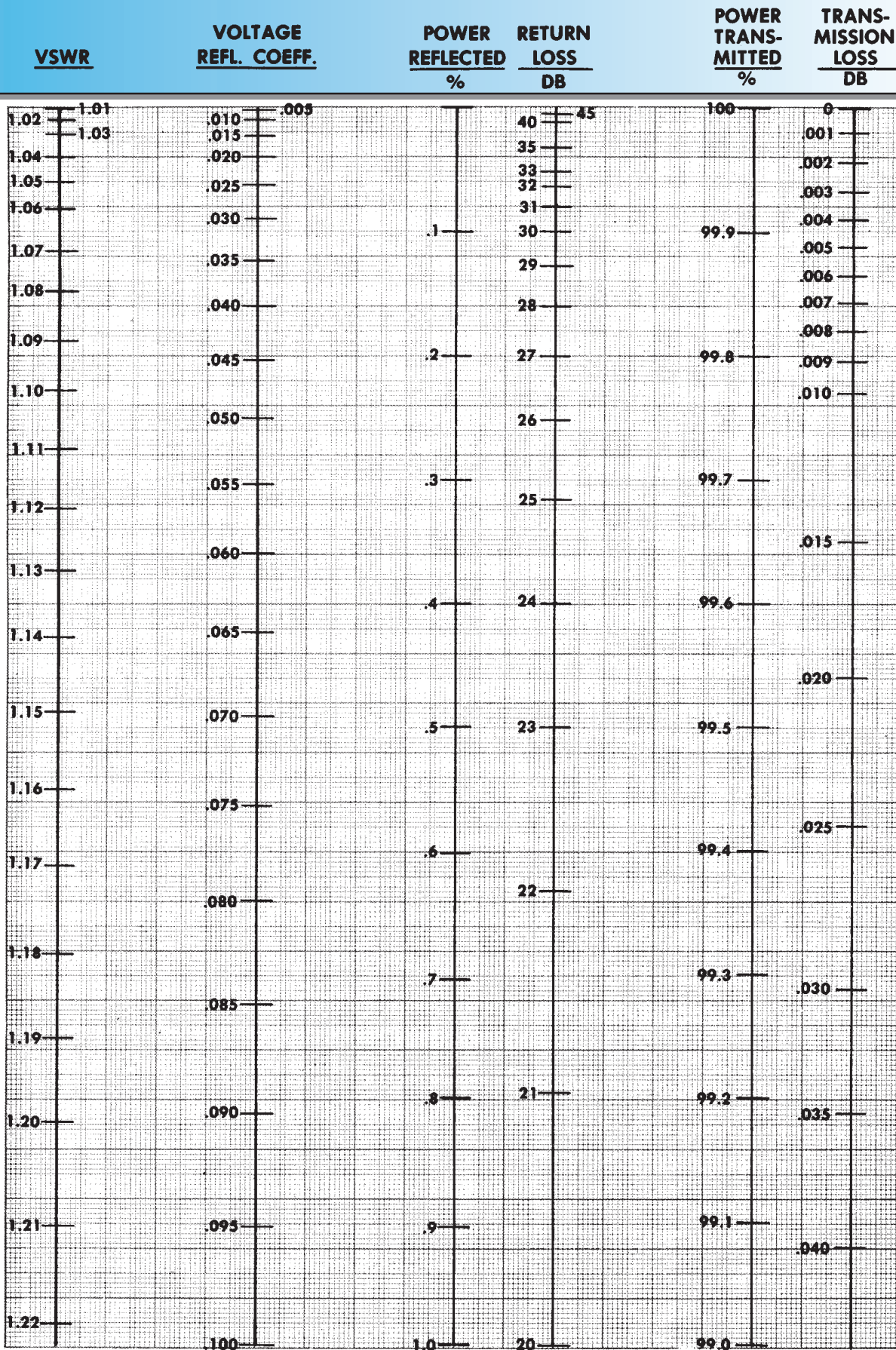

TEMPERATURE CONVERSION CHART

How to use this temperature conversion chart:

Blue numbers refer to temperature (in degrees Celsius or Fahrenheit) which it is desired to convert into the other scale. When converting from Fahrenheit to Centigrade read equivalent temperature in left column. When converting from Centigrade to Fahrenheit find equivalent temperature in right column. Temperatures not listed may be determined using the formulas found on page 6

While every precaution has been taken to ensure accuracy and completeness in this catalog, **Electro Impulse Laboratory, Inc.** assumes no responsibility, and disclaims all liability for damages resulting from use of this information or for any errors or omissions.

°C	°F	°C	°F	°C	°F
-56.7	-70	-94.0	-1.1	30	86.0
-51.1	-60	-76.0	-0.6	31	87.8
-45.6	-50	-58.0	0.0	32	89.6
-40.0	-40	-40.0	0.6	33	91.4
-39.4	-39	-38.2	1.1	34	93.2
-38.9	-38	-36.4	1.7	35	95.0
-38.3	-37	-34.6	2.2	36	96.8
-37.8	-36	-32.8	2.8	37	98.6
-37.2	-35	-31.0	3.3	38	100.4
-36.7	-34	-29.2	3.9	39	102.2
-36.1	-33	-27.4	4.4	40	104.0
-35.6	-32	-25.6	5.0	41	105.8
-35.0	-31	-23.8	5.6	42	107.6
-34.4	-30	-22.0	6.1	43	109.4
-33.9	-29	-20.2	6.7	44	111.2
-33.3	-28	-18.4	7.2	45	113.0
-32.8	-27	-16.6	7.8	46	114.8
-32.2	-26	-14.8	8.3	47	116.6
-31.7	-25	-13.0	8.9	48	118.4
-31.1	-24	-11.2	9.4	49	120.2
-30.6	-23	-9.4	10.0	50	122.0
-30.0	-22	-7.6	10.6	51	123.8
-29.4	-21	-5.8	11.1	52	125.6
-28.9	-20	-4.0	11.7	53	127.4
-28.3	-19	-2.2	12.2	54	129.2
-27.8	-18	-0.4	12.8	55	131.0
-27.2	-17	1.4	13.3	56	132.8
-26.7	-16	3.2	13.9	57	134.6
-26.1	-15	5.0	14.4	58	136.4
-25.6	-14	6.8	15.0	59	138.2
-25.0	-13	8.6	15.6	60	140.0
-24.4	-12	10.4	16.1	61	141.8
-23.9	-11	12.2	16.7	62	143.6
-23.3	-10	14.0	17.2	63	145.4
-22.8	-9	15.8	17.8	64	147.2
-22.2	-8	17.6	18.3	65	149.0
-21.7	-7	19.4	18.9	66	150.8
-21.1	-6	21.2	19.4	67	152.6
-20.6	-5	23.0	20.0	68	154.4
-20.0	-4	24.8	20.6	69	156.2
-19.4	-3	26.6	21.1	70	158.0
-18.9	-2	28.4	21.7	71	159.8
-18.3	-1	30.2	22.2	72	161.6
-17.8	0	32.0	22.8	73	163.4
-17.2	1	33.8	23.3	74	165.2
-16.7	2	35.6	23.9	75	167.0
-16.1	3	37.4	24.4	76	168.8
-15.6	4	39.2	25.0	77	170.6
-15.0	5	41.0	25.6	78	172.4
-14.4	6	42.8	26.1	79	174.2
-13.9	7	44.6	26.7	80	176.0
-13.3	8	46.4	27.2	81	177.8
-12.8	9	48.2	27.8	82	179.6
-12.2	10	50.0	28.3	83	181.4
-11.7	11	51.8	28.9	84	183.2
-11.1	12	53.6	29.4	85	185.0
-10.6	13	55.4	30.0	86	186.8
-10.0	14	57.2	30.6	87	188.6
-9.4	15	59.0	31.1	88	190.4
-8.9	16	60.8	31.7	89	192.2
-8.3	17	62.6	32.2	90	194.0
-7.8	18	64.4	32.8	91	195.8
-7.2	19	66.2	33.3	92	197.6
-6.7	20	68.0	33.9	93	199.4
-6.1	21	69.8	34.4	94	201.2
-5.6	22	71.6	35.0	95	203.0
-5.0	23	73.4	35.6	96	204.8
-4.4	24	75.2	36.1	97	206.6
-3.9	25	77.0	36.7	98	208.4
-3.3	26	78.8	37.2	99	210.2
-2.8	27	80.6	37.8	100	212.0
-2.2	28	82.4	40.6	105	221.0
-1.7	29	84.2	43.3	110	230.0
46.1	115	239.0	48.9	120	248.0
51.7	125	257.0	54.4	130	266.0
57.2	135	275.0	60.0	140	284.0
62.8	145	293.0	65.6	150	302.0
68.3	155	311.0	71.1	160	320.0
73.9	165	329.0	76.7	170	338.0
79.4	175	347.0	82.2	180	356.0
84.9	185	365.0	87.8	190	374.0
90.4	195	383.0	93.3	200	392.0
95.9	205	401.0	98.9	210	410.0
101.4	215	419.0	104.4	220	428.0
106.9	225	437.0	110.0	230	446.0
112.4	235	455.0	115.6	240	464.0
117.9	245	473.0	121.1	250	482.0
123.4	255	491.0	126.7	260	500.0
128.9	265	509.0	132.2	270	518.0
134.4	275	527.0	137.8	280	536.0
139.9	285	545.0	143.3	290	554.0
145.4	295	563.0	148.9	300	572.0
150.9	305	581.0	154.4	310	590.0
156.4	315	600.0	160.0	320	608.0
161.9	325	618.0	165.6	330	626.0
167.4	335	636.0	171.1	340	644.0
172.9	345	654.0	176.7	350	662.0
178.4	355	672.0	182.2	360	680.0
183.9	365	690.0	187.8	370	698.0
189.4	375	708.0	193.3	380	716.0
194.9	385	726.0	198.9	390	734.0
200.4	395	744.0	204.4	400	752.0
205.9	405	762.0	210.0	410	770.0
211.4	415	780.0	215.6	420	788.0
216.9	425	798.0	221.1	430	806.0
222.4	435	816.0	226.7	440	824.0
227.9	445	834.0	232.2	450	842.0
233.4	455	852.0	237.8	460	860.0
238.9	465	870.0	243.3	470	878.0
244.4	475	888.0	248.9	480	896.0
249.9	485	906.0	254.4	490	914.0
255.4	495	924.0	260.0	500	932.0
260.9	505	942.0	265.6	510	950.0
266.4	515	960.0	271.1	520	968.0
271.9	525	978.0	276.7	530	986.0
277.4	535	996.0	282.2	540	1004.0
282.9	545	1014.0	287.8	550	1022.0
288.4	555	1032.0	293.3	560	1040.0
293.9	565	1050.0	298.9	570	1058.0
299.4	575	1068.0	304.4	580	1076.0
304.9	585	1086.0	310.0	590	1094.0
310.4	595	1104.0	315.6	600	1112.0
315.9	605	1122.0	321.1	610	1130.0
321.4	615	1140.0	326.7	620	1148.0
326.9	625	1158.0	332.2	630	1166.0
332.4	635	1176.0	337.8	640	1184.0
337.9	645	1194.0	343.3	650	1202.0



ELECTRO IMPULSE LABORATORY, INC.

1805 Route 33, P.O. Box 278

Neptune, NJ 07754-0278

Fax: (732) 776-6793 Phone: (732) 776-5800

Visit our Web Site: www.electroimpulse.com